

# Intermodulation Distortion in Gramophone Pickups

By S. KELLY\*

## Methods of Measurement Using Special Test Records

**I**N general, the criterion of the fidelity of a reproducing system has in the past been expressed in terms of two major forms of distortion, namely, variations of amplitude with frequency for constant input, and non-linearity of the transfer characteristic relating output to input over a wide range of amplitudes. Later, recognition was given to phase distortion and transient distortion.

Amongst the earlier methods of specifying performance were those relating the gain of the amplifier to the frequency of the input wave, and usually any components of the output wave differing in frequency from that of the input were neglected. This gives only a rough and ready check of the performance of the amplifier, because the distortion due to a variation in frequency response, as perceived aurally, is usually not very serious. A more distressing form of distortion is that due to non-linearity of the response to input waves of varying amplitude. In this case, the amplitude of the output wave is not directly proportional to that of the input, and it can be shown, where non-linearity exists, that for a pure sinusoidal input the output will contain, in addition to the fundamental frequency, other frequencies harmonically related to it. For the past two decades, the system of assessing non-linearity has been to measure the ratio of the total (r.m.s.) harmonics produced in the device to the fundamental frequency.

Where the harmonics are concordant with the fundamental, the aural effect is less distressing than when inharmonic frequencies are present. As a matter of interest, taking the series as far as the tenth

harmonic, only the seventh and ninth harmonics are not musically related to the fundamental. Harmonic distortion, as far as it goes, gives a good measure of the fidelity of the unit but, unfortunately, in most forms of aural communication, two or more frequencies are transmitted simultaneously, and it is generally agreed that simple harmonic distortion is not nearly so distressing as forms of distortion where waves other than those harmonically related to the fundamental are generated. If two different frequencies are applied to a non-linear network, the output wave, in addition to containing the two original and their harmonically related frequencies, produces also combination tones of these two groups, and the majority of these combination tones will not bear any simple harmonic relation to any of the fundamental tones.

Intermodulation is the production of new components having frequencies corresponding to undesired sums and differences of the fundamental and harmonic frequencies of the applied waves. By generally accepted definition, the intermodulation distortion is the arithmetic sum of the amplitudes of the modulation products divided by the amplitude of the high-frequency carrier. The intermodulation system of testing was first described by Harris<sup>1</sup> and was further developed by Frayne and Scoville<sup>2</sup>; a recent analysis is given by Fine<sup>3</sup>.

In a gramophone pickup, distortion can take place due to non-linear flux variation in the pickup coil, caused by the armature moving through a non-linear magnetic field; hysteresis in the iron magnetic circuit; and various other design faults; or, more generally, due to the stylus not tracking the groove correctly. (In this article, the "tracking" capabilities of a pickup refer to the ability of the stylus to maintain contact with both walls of the groove under normal operating conditions.)

Under ideal conditions, the stylus would maintain constant contact with both walls of the groove, and the force acting on the stylus would be symmetrical about the vertical centre line. If, however, the vertical force on the stylus is insufficient, the stylus will tend to ride up one or other of the groove walls. This is particularly noticeable on loud passages, and if the acceleration is sufficient, it is possible to throw the stylus completely out of the groove and for it to come to rest one or more grooves away. This distressing phenomenon is only too apparent to most users of the gramophone.

Fig. 1. Variation with frequency of the mechanical impedance at the needle top of a popular commercial pickup (1 Newton = 105 dynes).

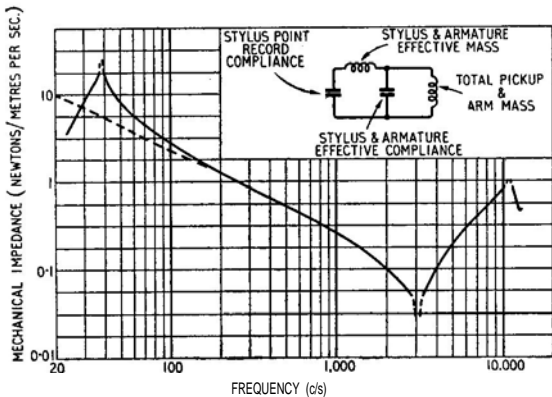

\* Cosmocord, Ltd.

1. J. H. O. Harris *Wireless Engineer*. Vol. 14, pp. 63-72. Feb., 1937.
2. J. G. Frayne and R. R. Scoville. *F. soc. Mot. Pic. Eng.* Vol. 32, pp. 648-674. June, 1939.
3. R. S. Fine. *Audio Engineering*. Vol. 34, pp. 11-14. July, 190.

Fig. 1 shows the mechanical needle tip impedance of a popular commercial pickup. It will be seen that it consists of two high-impedance points corresponding to high-frequency and low-frequency parallel resonances and a series-resonant frequency (minimum impedance) at 3 kc/s. The high-frequency resonance is determined by the effective mass of the armature and stylus system and the total compliance of the stylus system (the needle tip to record compliance, and the compliance of the stylus itself), and the low-frequency resonance by the mass of the pickup head and the total armature and stylus compliance. When the needle pressure is insufficient, the stylus will "jump the groove" on heavy low-frequency passages, and rattle, or in extreme cases, also "jump the groove" because of the large accelerations often experienced at the high-frequency end.

This particular phenomenon has been evident since the earliest days of recorded sound and is one of the major problems in pickup design to-day; and the advent of long-playing records has done nothing to ease the design problem. The tracking capabilities of a pickup are determined to a large extent by the mechanical impedance at the stylus tip and, as stated before, if the lateral thrust exerts a force greater than

It is intended that the test records be used with a correct bass compensating circuit, so that the equalized output from the pickup is flat when played from a standard recording. The difference level of the two frequencies will then be 12db on the JH 138.

The specification of the record is as follows:  
*1st side:* The outer band consists of 400-c/s tone at a level of plus 22.5db, referred to a lateral velocity of 1 cm/sec (r.m.s.), with approximately 4,000c/s at a level of plus 10.5db superimposed additively. The difference in levels is 12db, and an exact integral frequency ratio has been avoided in order to facilitate visual observation of the envelope on a cathode ray tube screen.

The peak lateral velocity of the combined wave is equal to that of a sine wave at a level of plus 24.5db.

The succeeding ten bands each have the level of both tones (and hence of the combination), reduced by 2db below that of the foregoing band.

*2nd side:* The outer band consists of 60-c/s tone at a level of plus 8.6db, with 2,000-c/s tone at a level of plus 10.3db superimposed additively. When the 2,000c/s is reduced in the pickup bass-correction equalizer by the correct amount relative to 60c/s (i.e., 13.7db) its effective level will be minus 3.4db (and

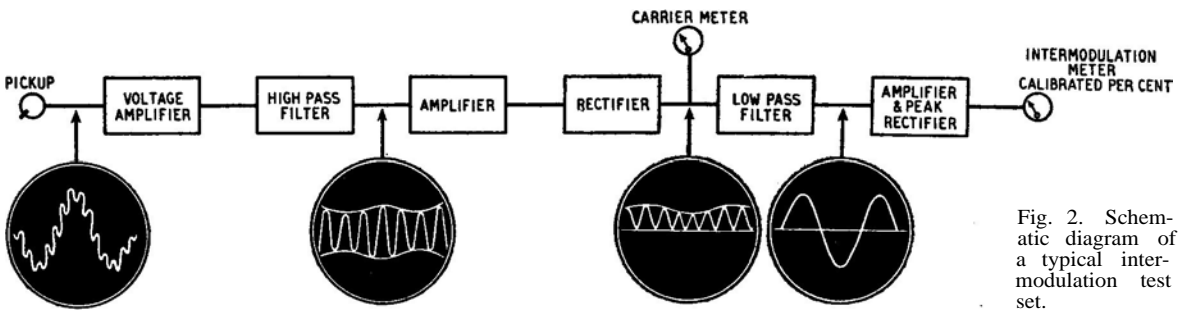

Fig. 2. Schematic diagram of a typical intermodulation test set.

that due to the downward pressure, the stylus will tend to ride up the walls of the groove and the symmetrical deflection of the stylus will be lost. This form of distortion is probably the most serious encountered in present-day gramophone reproduction. Unfortunately, the measurement of the mechanical impedance at the stylus point is an extremely difficult matter, but in view of the very high accelerations to which the stylus is subjected, a simple statement of its mechanical impedance is not always sufficient, and some system is required which will show the slightest form of distortion arising from failure to maintain contact between stylus and groove wall. The measurement of intermodulation is about three to five times more sensitive than the measurement of simple harmonic distortion, and this system can easily be adapted to check the tracking capabilities of the gramophone pickup.

The starting point for intermodulation measurements on gramophone pickups is, of course, a record which is engraved with the necessary frequencies and which, in itself, possesses negligible intermodulation components. The intermodulation test record No. JH 138 produced by E.M.I. Studios, Ltd., has been developed for the specific purpose of checking pickups. It runs at 78 r.p.m. and is cut with a standard groove shape, for use with 0.0025in radius styli. One side is cut at 60c/s and 2,000c/s, and the reverse side at 400c/s and 4,000c/s.

not 1.4db as stated on the record information sheet), i.e., 12db below the level of the 60-c/s tone.

On a velocity basis, the peak lateral velocity of the combined wave is equal to that of a sine wave at a level of plus 15.5db.

The peak combined amplitude is equivalent to that of a 60-c/s sine wave having a level of plus 10db.

The succeeding ten bands each have the level of both tones (and hence of the combination) reduced by 2db below that of the foregoing band. NOTE: The level in decibels above a zero of 1 cm/sec r.m.s. lateral velocity has been measured by the Buchmann and Meyer optical method.

### Tolerable Distortion levels

Frequencies of 400c/s and 4,000c/s were chosen because these lie between the two usual resonant frequencies of the pickup system, and are located in the area where high peak energies of speech and music are usually met with. Much practical work has been done, using these frequencies, in the film industry, and it has been shown that if the 400-c/s component has an amplitude 12db greater than the 4,000-c/s component, extremely good correlation exists between aural and measured distortion. Direct listening tests show that when using 400-4,000c/s, 10 per cent is a good practical limit for tolerable distortion. Below 10 per cent the distortion is not readily detectable

unless directly compared with the original source. The majority of commercial pickups have the low-frequency resonance between 40 c/s and 80 c/s and it is usually the mechanical impedance of the needle tip at this low resonant frequency that finally determines the tracking capabilities of the pickup. The reverse side of the record is therefore cut with a 60-c/s low frequency component and a 2,000 c/s high frequency component in order to meet these particular tracking test requirements.

The output from the pickup is connected to the intermodulation test set shown in Fig. 2. This consists of a preamplifier of variable gain and minimum distortion (less than 0.5 per cent), a high-pass filter which eliminates the 60-c/s or 400-c/s wave, a buffer amplifier and a rectifier. The output of the rectifier is taken through a low-pass filter to a further buffer amplifier and a peak-reading voltmeter. The carrier level is monitored on the output of the rectifier. It may be possible to give constructional details of this equipment in a subsequent article.

Whilst an intermodulation test set is a very desirable piece of laboratory furniture, it is not absolutely necessary, and much information may be gained by direct listening to the output from the pickup when played on the intermodulation record. The distortion produced when the pickup is not tracking correctly, or when there are any other faults in the amplifier, is much more easily detectable than by listening to single-tone records—the overload point can be determined to a precision of approximately 2db, these

being the amplitude differences between each band. Fig. 3 shows a very simple set-up using standard laboratory components and a cathode ray oscilloscope. The percentage distortion is given by:

$$\frac{A-B}{A+B} \cdot 100$$

and gives reproducible results within a few per cent. The c.r.o. trace is shown in Fig. 4.

The inductances indicated in Fig. 3 were constructed with Mullard "Ferroxcube" cores in order to reduce distortion to a minimum. Using Type Y25/11.3 core and former assemblies, 1,750 turns of 42-s.w.g. enamelled wire gave 1.5henrys and 3,400 turns of 45-s.w.g. were required for 5henrys. Final adjustment of inductance to give resonance at the required frequency with the actual circuit capacitance was made by rubbing down the centre core or the outer ring to vary the effective air gap. An alternative method would be to use fixed inductances (e.g., Salford Electrical "Gecalloy" toroidal coils on Type GIA cores) and to make any necessary adjustments in the capacitance. If the core is constructed from Stalloy or equivalent material, it must be of adequate cross section and well gapped to reduce iron distortion to the minimum.

In operation, the record is played (starting at the lowest velocity on the inside band) using various needle pressures, and the distortion noted for each band. Typical results are shown in Fig. 5. These were obtained using a medium-priced, general-

	$f_+$ 60c/s	$f_+$ 400c/s
C <sub>1</sub>	0.1 μF	0.02 μF
C <sub>2</sub>	1.5 μF	0.15 μF
L <sub>1</sub>	5 H	1.5 H
R	5kΩ	8kΩ

ADJUST FOR MAX. ATTENUATION AT TEST FREQUENCY

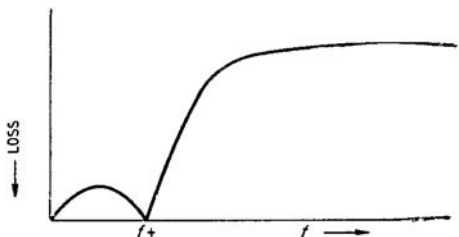
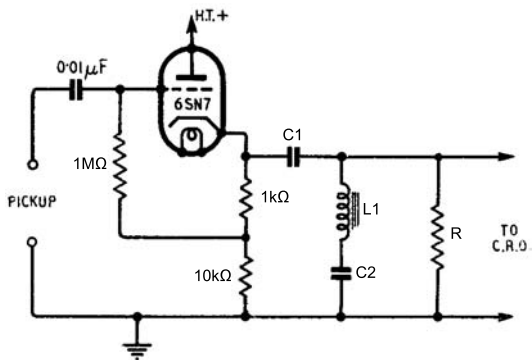

Fig. 3. Simple cathode-follower coupling circuit for measuring intermodulation with a cathode ray oscilloscope. The shape of the response curve is shown inset.

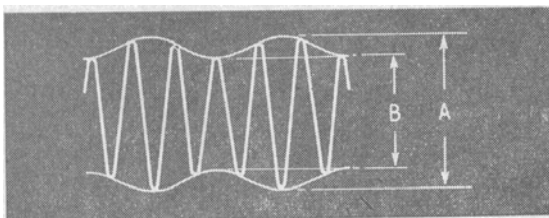
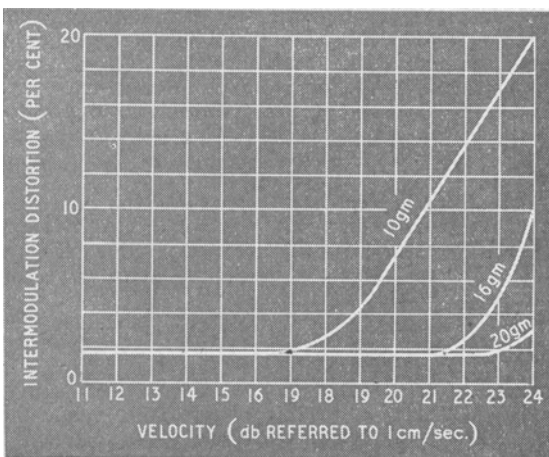

Fig. 4. Form of trace obtained with circuit of Fig. 3.

Fig. 5. Typical results with different needle pressures for a medium-priced general-purpose pickup using test frequencies of 400 and 4,000 c/s.



purpose pickup. On the 400-4,000c/s side, it is seen that the distortion is low at low velocities, but at a critical velocity the distortion increases very rapidly. Increasing the needle pressure increases the velocity at which the break-up occurs and, for a given needle pressure, this point may be defined as the maximum velocity the pickup will track. Fig. 6 shows results on the same pickup when used on the 60-2,000c/s side: (A) with the moment of inertia of the pickup adjusted for a resonant frequency of 60c/s, and (B) for 25c/s. This was achieved by weighting the head and counterbalancing the arm until the correct needle pressure was obtained. The necessity for reducing the low-frequency resonance as much as possible is certainly brought home in the test. It may be worth while mentioning here that where spring counterbalancing is used, extreme care must be exercised in measuring the needle pressure; during weighing, the height of the stylus from the baseboard must be exactly the same as the top of the record, otherwise large errors will be experienced.

In order to assess the tracking capabilities of the pickup, one determines the highest velocity with which the pickup will track for an intermodulation distortion of less than, say, 10 per cent. Of course, if two pickups are compared, one of which shows a minimum intermodulation distortion of, say, 7 per cent, and the discontinuity at plus 24db, and the second pickup shows distortion of only 1 per cent, and discontinuity at 20db, it will generally be considered that the second pickup is the better.

The maximum velocities recorded on the JH 138 approximate to those of commercial 78 r.p.m. recordings (except with pre-emphasis), and it is suggested that the needle pressure required to track successfully *all* bands of the record should be the one specified for

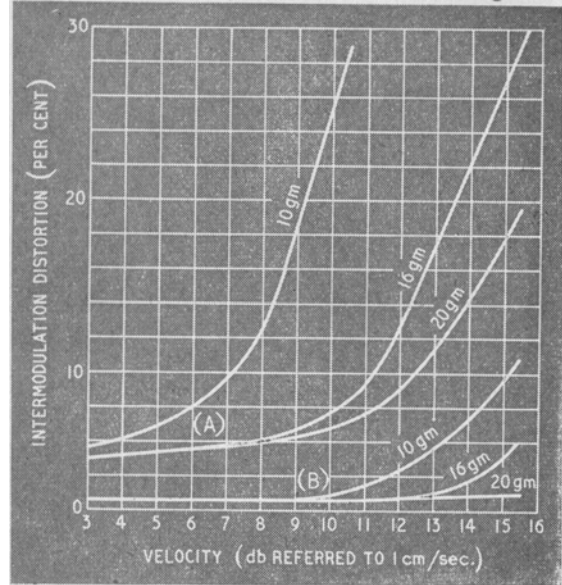

Fig. 6. Results with frequencies of 60 and 2,000 c/s for same pickup as Fig. 5. Low-frequency resonance adjusted (A) to 60 c/s and (B) to 25 c/s.

general use; of course, good engineering practice requires that some safety margin be allowed, but that is a question for the individual designer.

Acknowledgement is made to W. S. Barrell, B.Sc., and E. W. Berth-Jones, B.Sc., of E.M.I. Studios, Ltd. who produced the record used for these tests.